

The Drawer Box Company
INFORMATION PACK 2024

Contents

Calculating box dimensions

Handle cutouts, dropped fronts & sloped sides

Laser engraving

Cutlery & utensil inserts

Larder racks



Our dovetail drawer boxes are made in our workshop in Yorkshire from the highest quality materials.

15mm stock, dovetailed joints with the 10mm base grooved all round, notched and drilled for undermount drawer runners.

Available lacquered or raw finish.

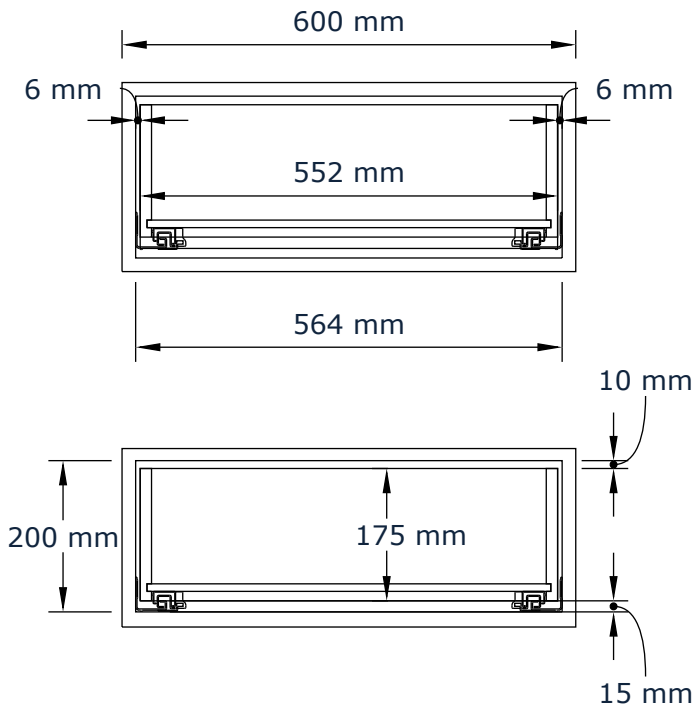

To calculate the width
Internal aperture minus 12mm

To calculate the height
Internal aperture minus 25mm
Available 50-700mm high.

To calculate the depth

*For drawer boxes notched both front & rear or rear only
Boxes available for runner lengths from 250 -750mm.*

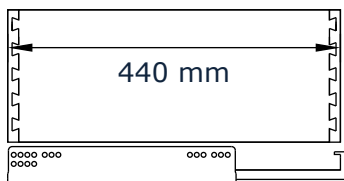

Notched front & rear
Runner length minus 10mm
Example shown: Drawer box notched front & rear for 450mm drawer runner.

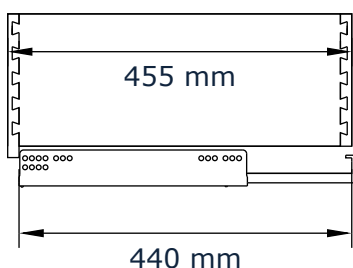

Notched rear only
Runner length plus 5mm
Example shown: Drawer box with dropped front rear notch only for 450mm drawer runner.

Handle cutout options

Available with dropped front only

A dropped front is required when the front of your drawer box is on show, for example in a pantry cabinet. We make the front 15mm lower than the sides and only notch the rear of the box to hide the locking devices. Note: this adds 15mm to the depth of the drawer box [440mm box = 455mm]. Dropped fronts are often combined with a handle cutout, either scoop or linear.

Scoop handle

Cutout: W77 H30mm

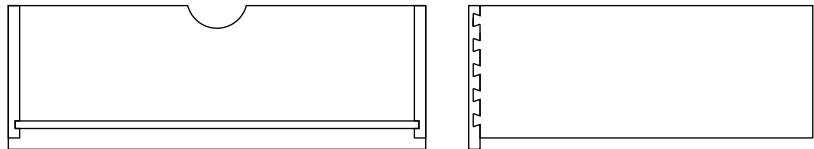

Linear 150mm

Cutout: W150 H20mm

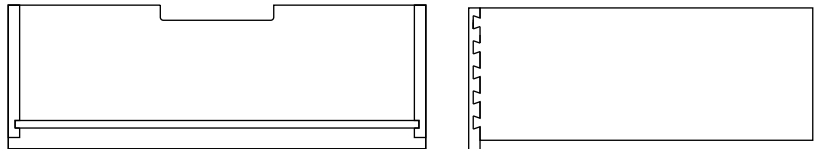

Linear 200mm

Cutout: W200 H20mm

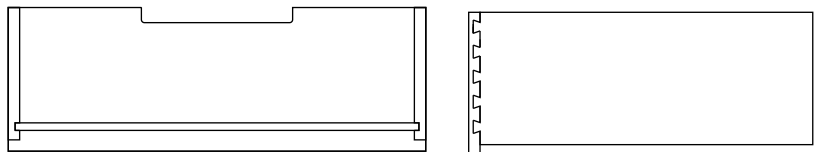

Linear 250mm

Cutout: W250 H20mm

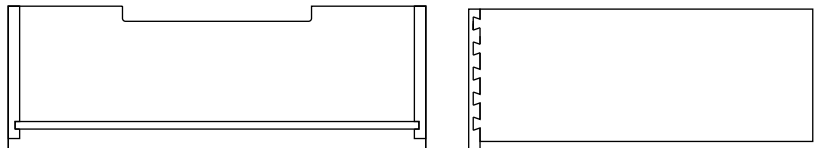

Sloped sides

Available with dropped front only

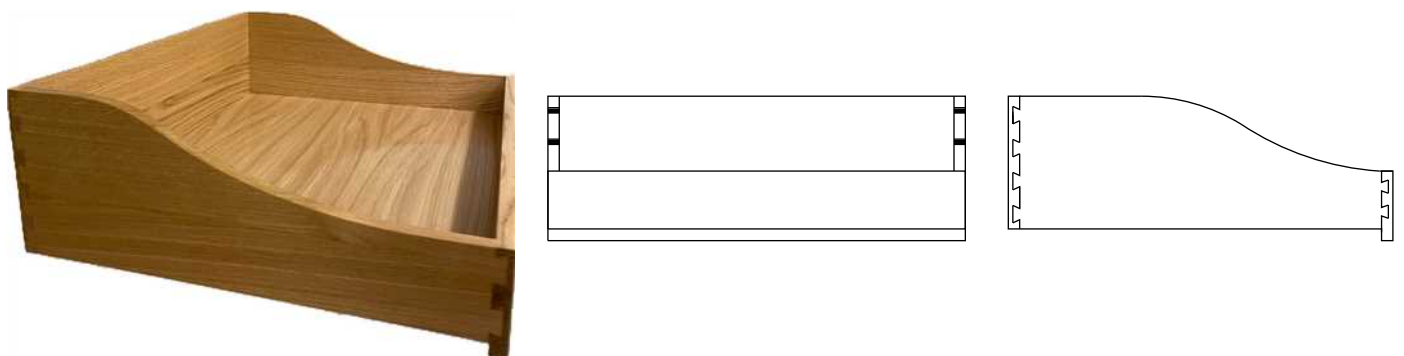

Laser engraving

Available on bespoke drawers only



Branding

Have your company branding laser engraved on the sides of your dovetail drawer boxes. Location shown is default unless specified otherwise.

Preferred file type - DXF

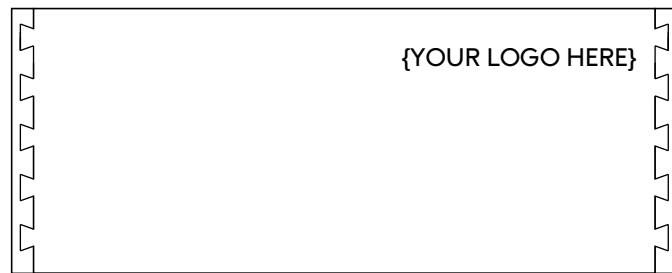

Front →

Letter carving

CNC engraving

CNC letter engraving with a choice of fonts.



Cutlery & Utensil inserts

Height 60mm

Standard layout

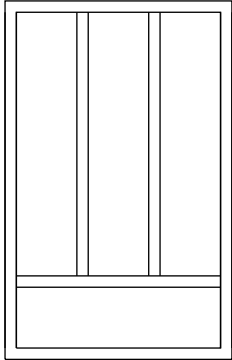

Small

Example shown W300mm

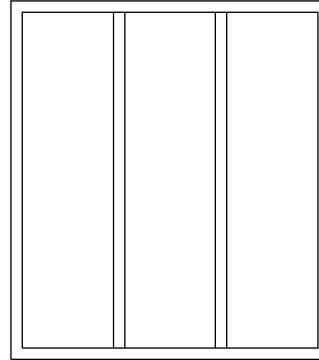

Small

Example shown W421mm

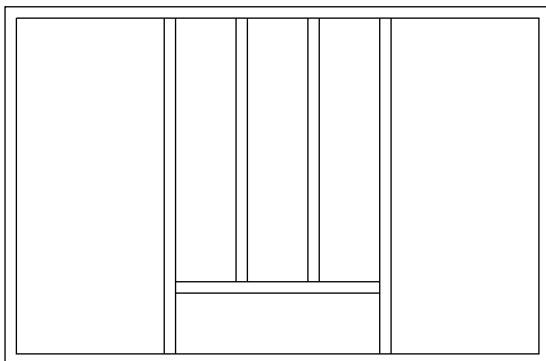

Medium

Example shown W721mm

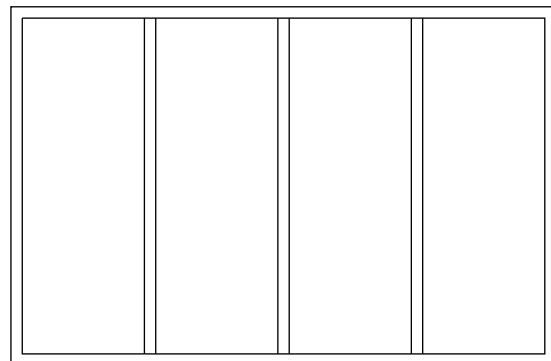

Medium

Example shown W721mm

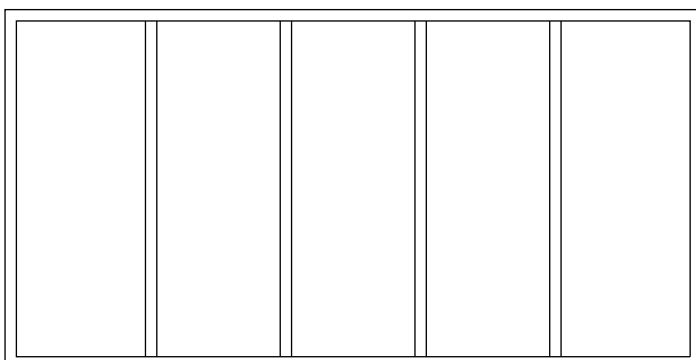

Large

Example shown W921mm

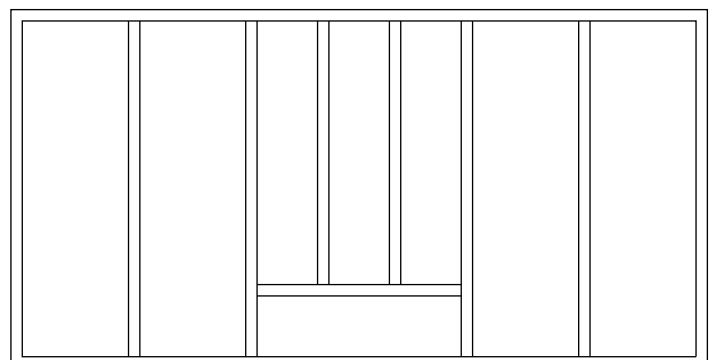

Large

Example shown W921mm

Contemporary

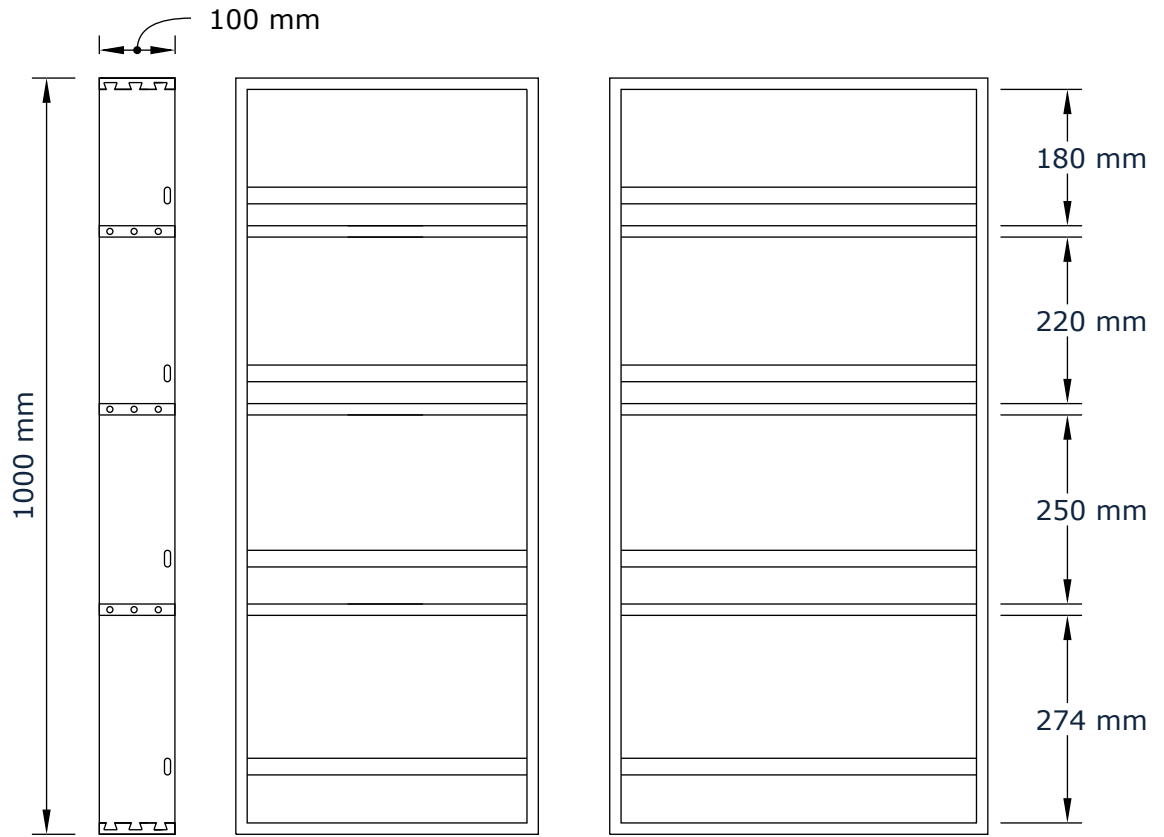

Traditional

